

W 949.384

# LAYOUT OF BOOM SYSTEM

SCALE 1:250

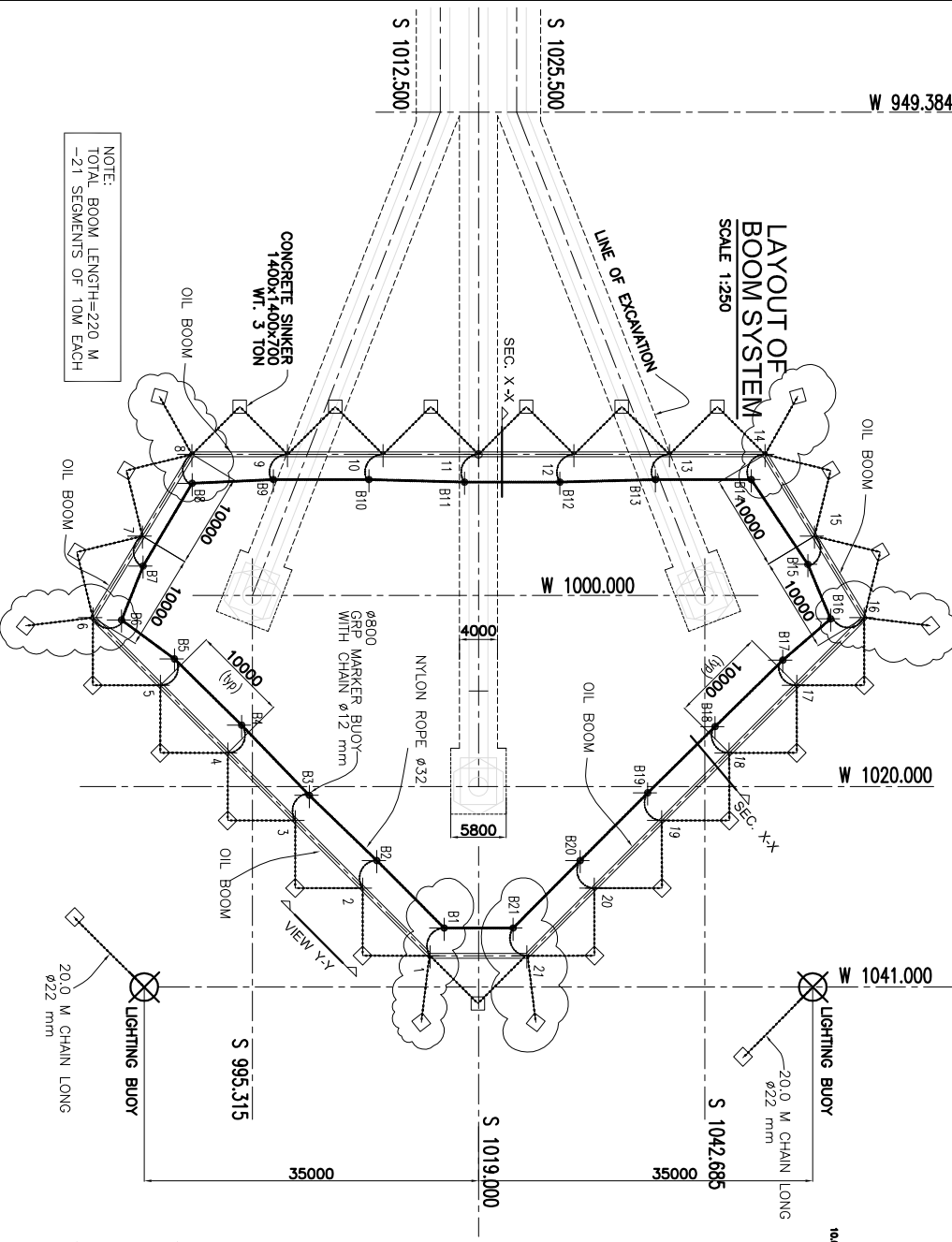

NOTE:  
TOTAL BOOM LENGTH=220 M  
-21 SEGMENTS OF 10M EACH

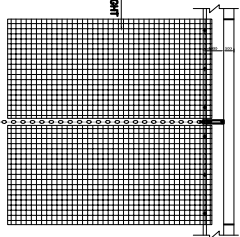

VIEW Z-Z  
SCALE 1:125

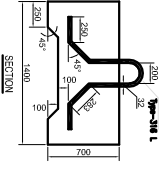

SECTION

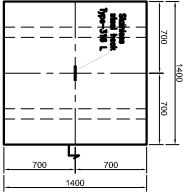

PLAN VIEW

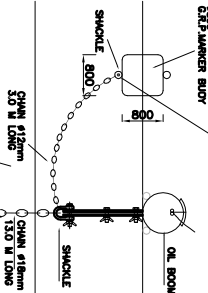

VIEW Y-Y

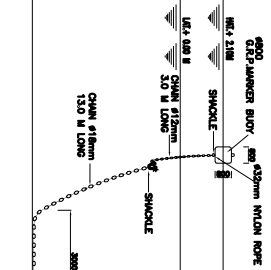

VIEW X-X

SECTION XX  
SCALE 1:125

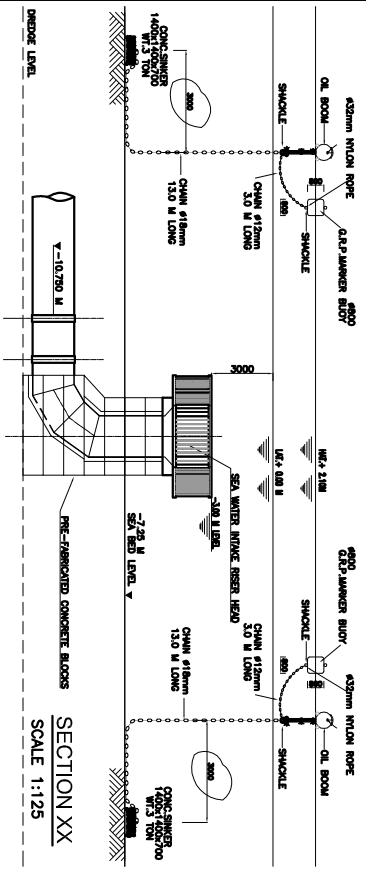

ARRANGEMENT OF CONNECTION OF BUOYS TO SINKER BLOCKS IF OIL BOOM IS REMOVED

ARRANGEMENT OF CONNECTION OF BUOYS TO SINKER BLOCKS WITH OIL BOOM

10 11 12 13 14 15 16 17 18 19 20 21